

Infrared APC Laser Module

APCD-780-07-C3-A&B

6-2D-LM78-009 Rev.01

Φ3.3mm 780nm Laser Module

Features

- APC (auto power control) IC inside
- Low current consumption of the APC circuit
- Much smaller LD module
- Surge current protection
- High quality lens for output beam



Absolute maximum ratings

Parameter	Symbol	Rating	Unit
Power supply voltage	V _{cc}	3.3	V
Laser Module optical output power	P _o	<3	mW
Operation temperature	T _{opr}	0~40	°C
Storage temperature	T _{stg}	0~60	°C

Electrical and optical characteristics (T_c=25 °C)

Parameter	Symbol	Min.	Typ.	Max.	Unit	Conditions
Wavelength	λ	-	785	-	nm	P _o = 3mW
Operation current	I _{op}	-	-	35	mA	P _o = 3mW ; V _{cc} =3V
Optical output power	P _{out}	2		3	mW	
Operation voltage	V _{op}	2.5	-	3.3	Volt	
Laser Beam spot size at 10m				<20mm		
Divergence angle				2 mrad		

* Sufficient heat dissipation is required for CW operation.

Outline dimensions (Units: mm)

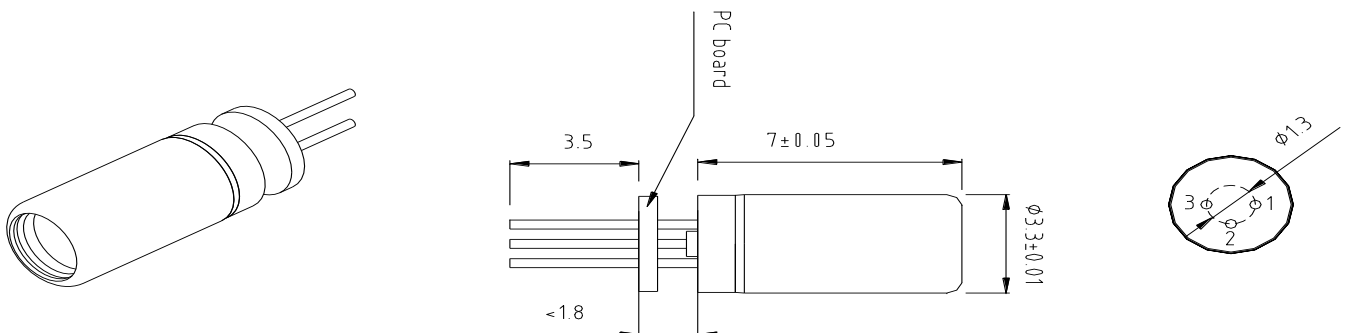

ARIMA LASERS CORP.

PHONE: 886-3-4699800 | FAX: 886-3-4699600

E-MAIL: Ldsales@arimalasers.com | www.arimalasers.com

For reference only. Contents above are subject to change without notice.

Arima
LASERS

Φ3.3mm 780nm Laser Module

Instruction manual

DC Power connection mode 1

A type : Heat sink stand (-)

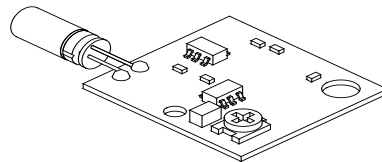
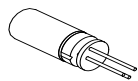
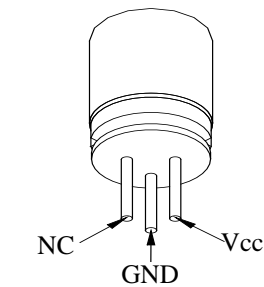

B type :Heat sink stand (+)

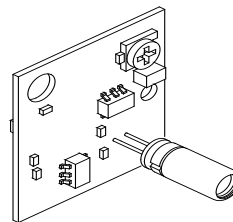
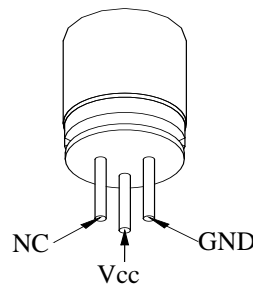

DC Power connection mode 2

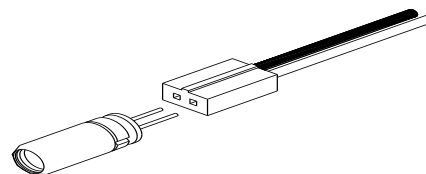
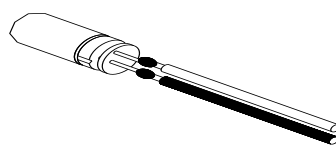
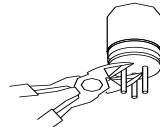
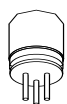

• Precautions

- * Do not operate the device above maximum ratings. Doing so may cause unexpected and permanent damage to the device.
- * Take precautions to avoid electrostatic discharge and/or momentary power spikes. A change in the characteristics of the laser or premature failure may result.
- * Proper heat sinking of the device assures stability and lifetime. Always ensure that maximum operating temperatures are not exceeded.
- * Observing visible or invisible laser beams with the human eye directly, or indirectly, can cause permanent damage. Use a camera to observe the laser.
- * No laser device should be used in any application or situation where life or property is at risk in event of device failure.
- * Specifications are subject to change without notice. Ensure that you have the latest specification by contacting us prior to purchase or use of the product.

ARIMA LASERS CORP.

PHONE: 886-3-4699800 | FAX: 886-3-4699600

E-MAIL: Ldsales@arimalasers.com | www.arimalasers.com

For reference only. Contents above are subject to change without notice.